

Article number: 12741000050110

Description: KLEE-coil 741 000 050.110
M5 Steel, zinc-pl. & chr. blue

Measures

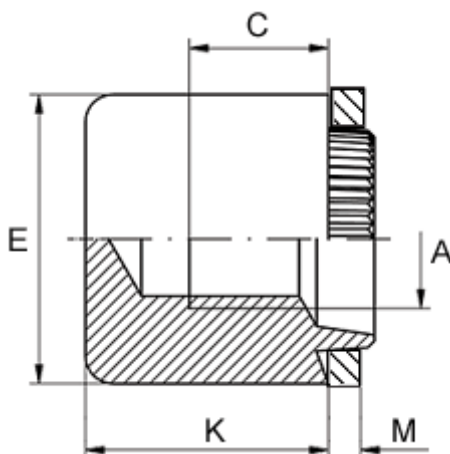

Female thread A	= M5
Height K	= 10.0
Min thread length C	= 5.0
Outer diameter E	= 11.0
Plate thickness	= 0.5 to 0.6
Recommended bore diameter for extreme load	= 8.0
Recommended bore diameter for normal use	= 8.0